

Structure: IP24113

Age Group: 2-12

ADA: Yes/Transfer

Dimensions: 30 'x17'x11'

Capacity: 25

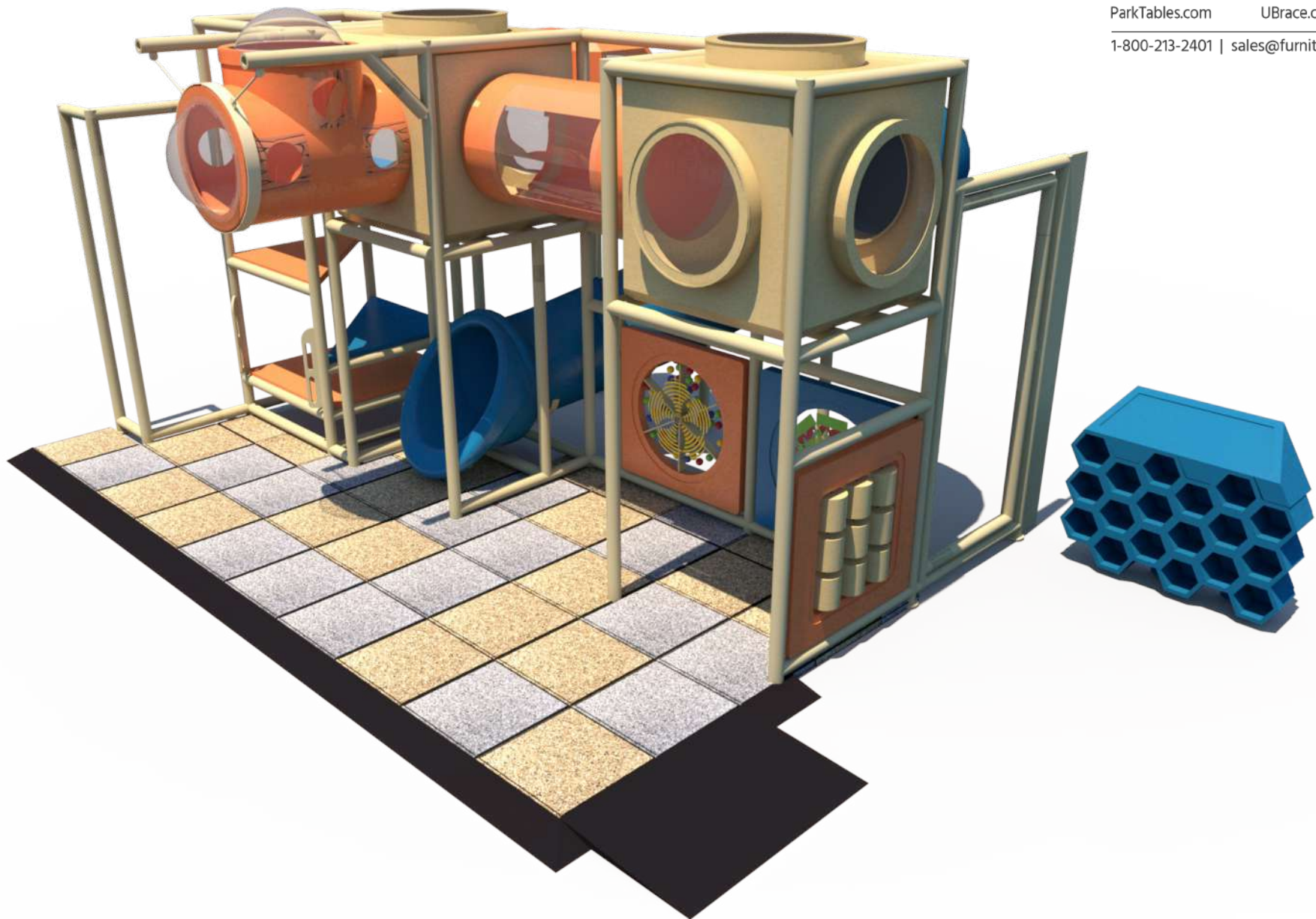

Structure: IP24113

Age Group: 2-12

ADA: Yes/Transfer

Dimensions: 30 'x17'x11'

Capacity: 25

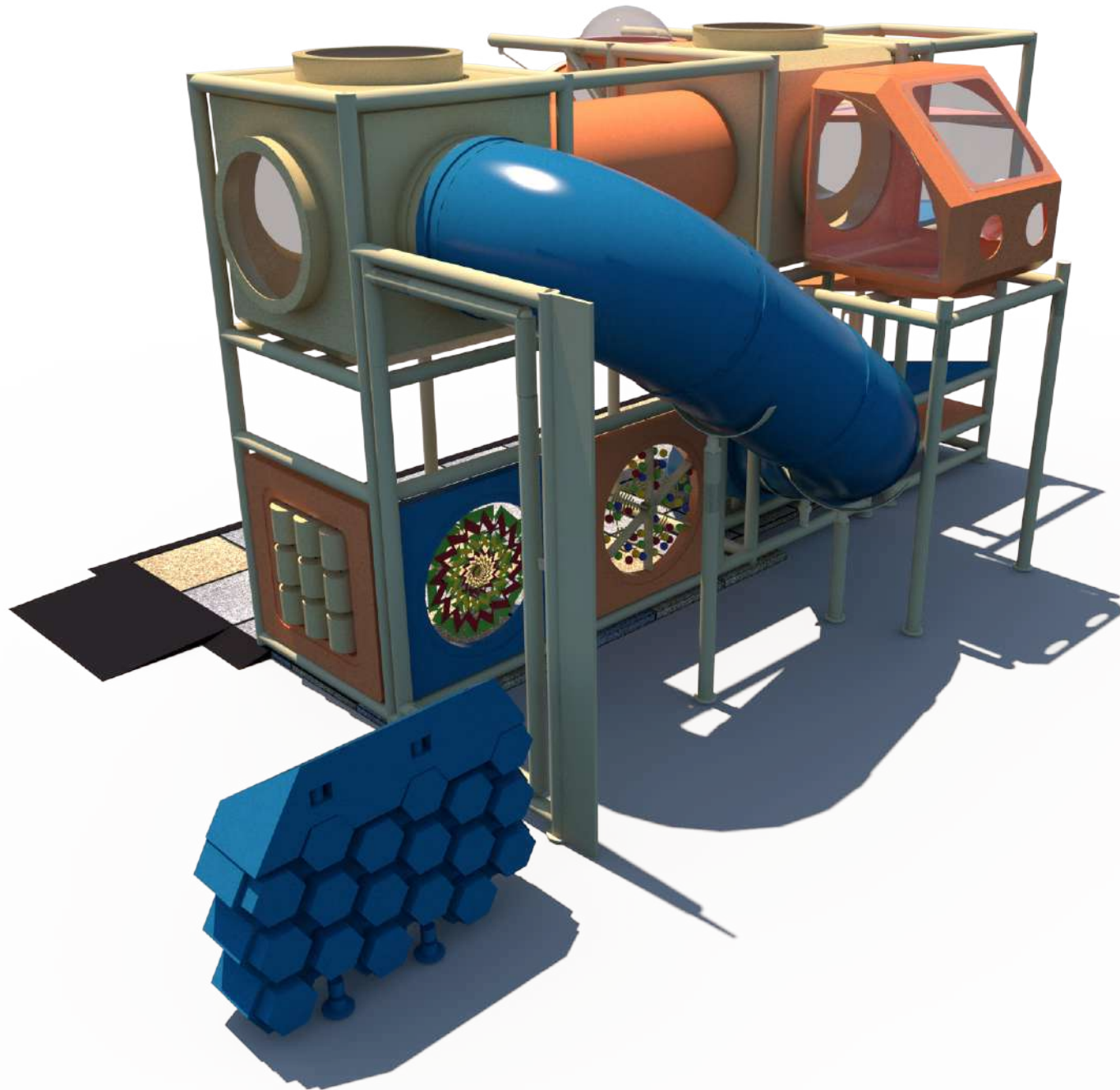

Structure: IP24113

Age Group: 2-12

ADA: Yes/Transfer

Dimensions: 30 'x17'x11'

Capacity: 25

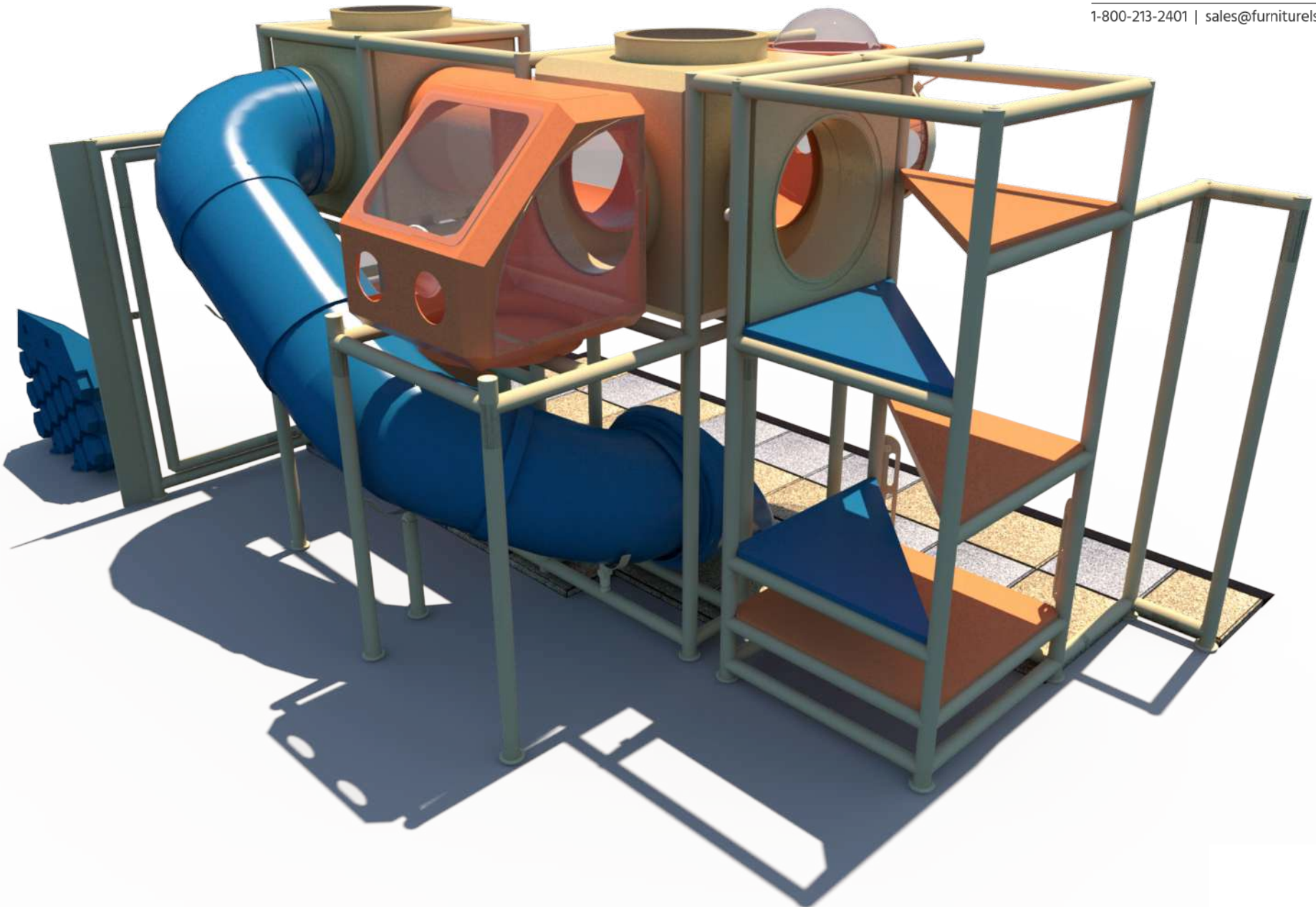

Structure: IP24113

Age Group: 2-12

ADA: Yes/Transfer

Dimensions: 30 'x17'x11'

Capacity: 25

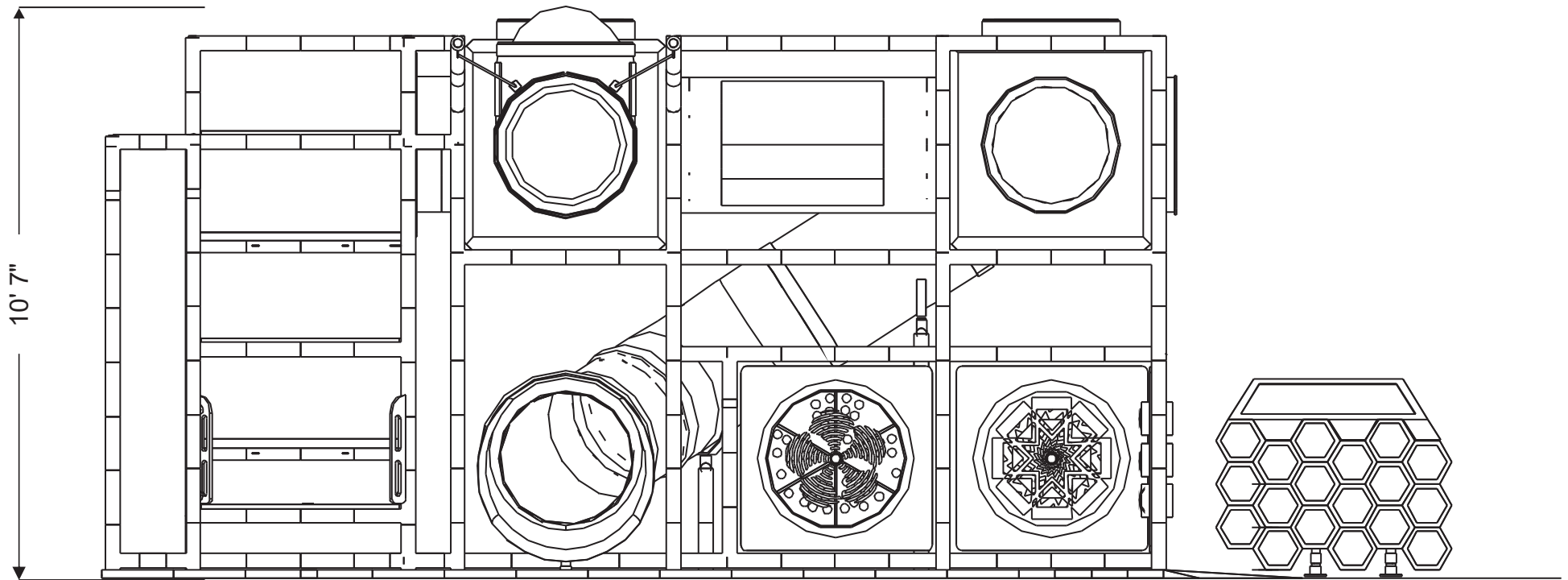

Structure: IP24113

Age Group: 2-12

ADA: Yes/Transfer

Dimensions: 30 'x17'x11'

Capacity: 25

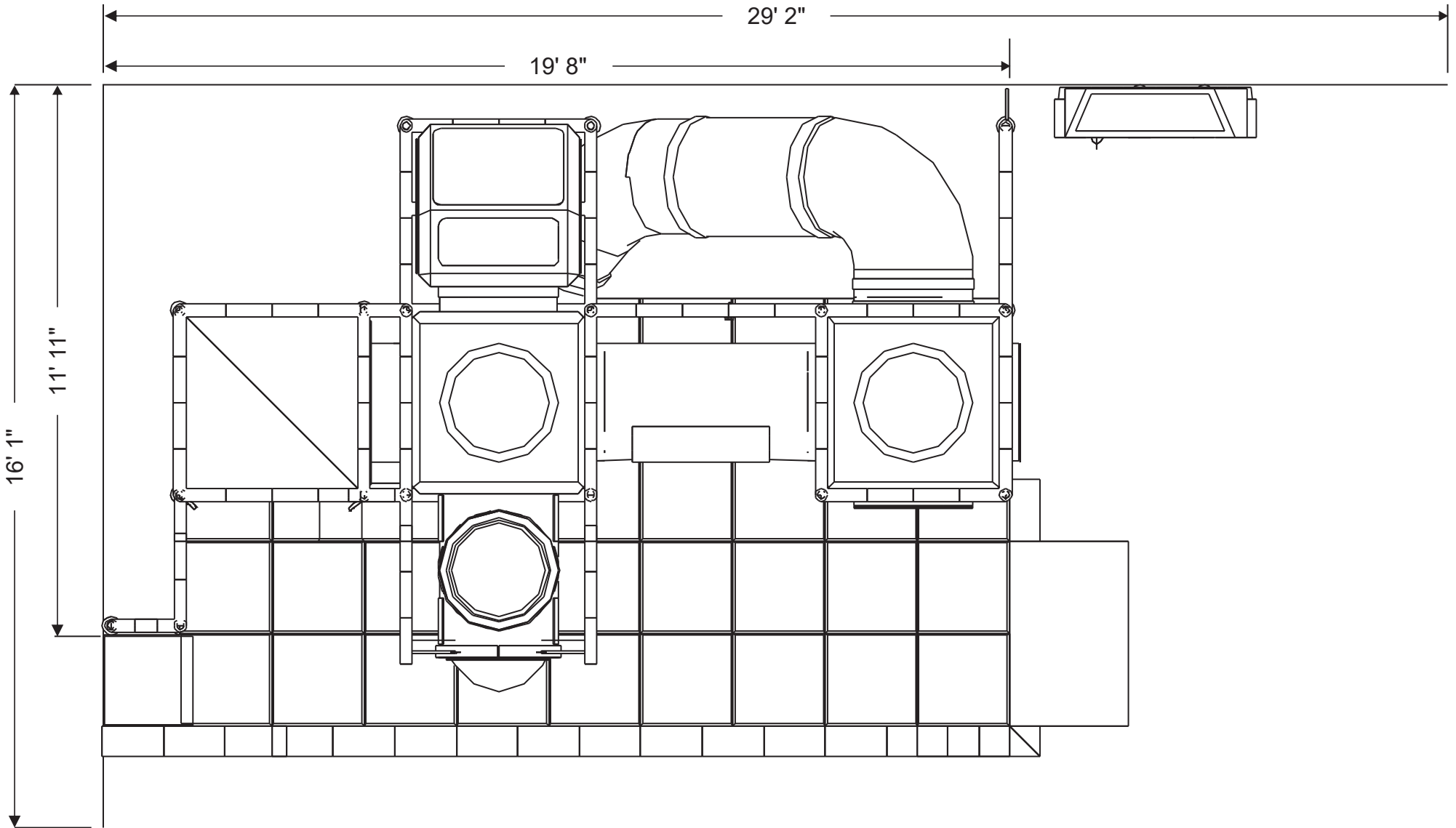

Structure: IP24113

Age Group: 2-12

ADA: Yes/Transfer

Dimensions: 30'x17'x11'

Capacity: 25

Activities and Events:



Gyro Activity Panel
Toddler Activity



Ball Turn Activity Panel
Toddler Activity



Tic-Tac-Toe
Activity Panel
Toddler Activity

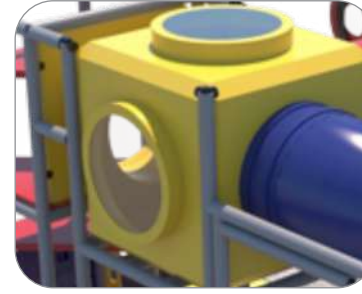

(2) Junction Cubes
with Lookout Windows



Turbo Car with
Steering Wheel &
Lookout Windows



5' Crawl Tunnel with
Lookout Windows



T-Tube Lookout
with Bubble Windows



6' 8" Enclosed
Curved Tube Slide

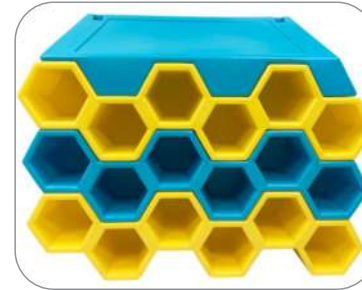

Sneaker Keeper



4 Level
Deck Climb

Structure: IP24113

Age Group: 2-12

ADA: Yes/Transfer

Dimensions: 30 'x17'x11'

Capacity: 25

Roto Plastic:



LIGHT GREY (LGY)



DARK YELLOW (DY)



ORANGE (OR)



WOODS ORANGE (WO)



TAN (TA)



BURGUNDY (BU)



DARK RED (DR)



PURPLE (PU)



GECKO GREEN (GC)



COBALT BLUE (CB)



TEAL (TE)



GREEN (GR)



KENTUCKY GREEN (KG)



ARIZONA TURQUOISE (AT)



CYAN (CY)



BLUE (BL)



Green, Blue, Yellow, Red, Tan, Black, Silver & White

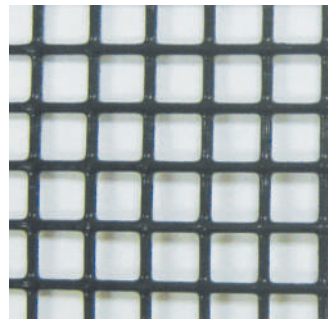

Black

Post Foam:

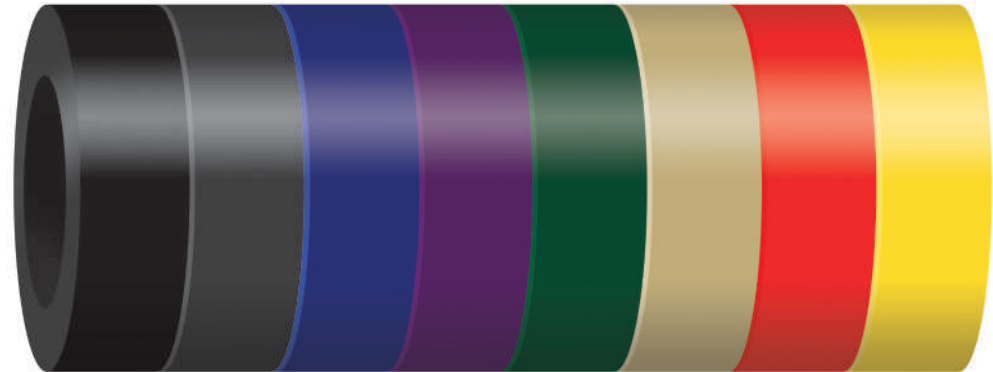

Black, Gray, Blue, Purple, Green, Tan, Red, & Yellow

HDPE:

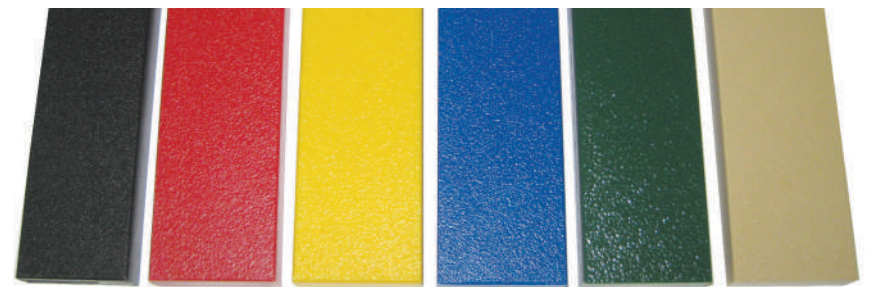

Black, Red, Yellow, Blue, Green, & Tan



BUFFING TOP

Pigmented using organic powder color coating methods that will not delaminate over time.
Sealed with specially formulated polymer agent that bonds pigments into the rubber.

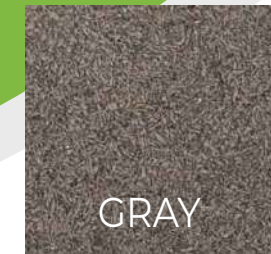
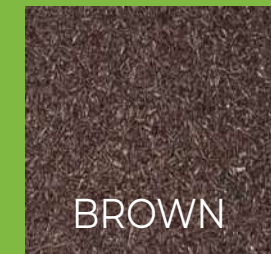

EPDM TOP

EPDM granules are used to create options from bright solids to special blends for specific color themes. Mixtures includes a vibrant 90% EPDM/40%black mesh for standout solids, a 50/50 mix with black mesh, and mixtures with up to 3 EPDM colors. Ask your rep about specific blends to cover your space needs.

STANDARD COLORS



BEIGE



BLUE



GREEN



RED

PREMIUM COLORS*



BRIGHT BLUE



DARK BLUE



DARK GREEN



PINK



LILAC



BRIGHT RED



BRIGHT GREEN



BRIGHT YELLOW



YELLOW



BRIGHT ORANGE



BEIGE BROWN



BROWN



WHITE



EGGSHELL



GRAY



MIDDLE GRAY



DARK GREY



GEZOFLEX
EPDM FOR SYNTHETIC FLOORING



90/10
BLUE

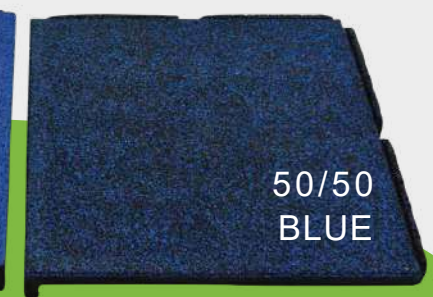

50/50
BLUE



45% GRAY
45% BLUE
10% BLACK MESH

**Premium colors subject to upcharges*